

LV Motors: IE2 Safe Area

Reliable & Long Lasting

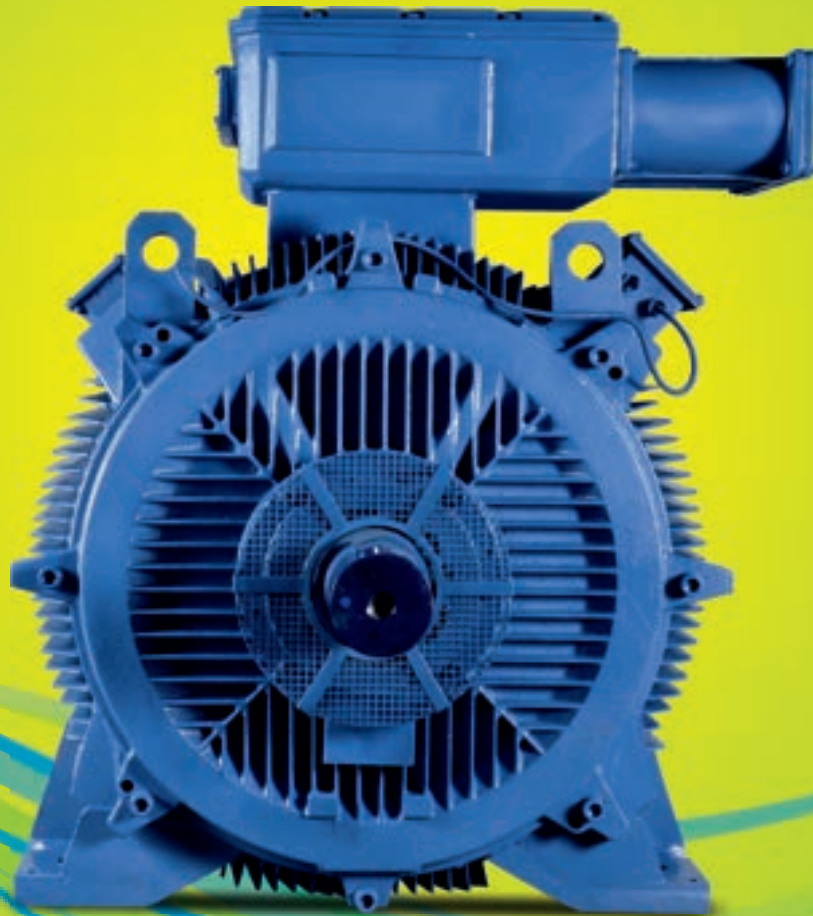

A MOTOR FOR EVERY NEED

BHARAT BIJLEE MOTORS: MILESTONES

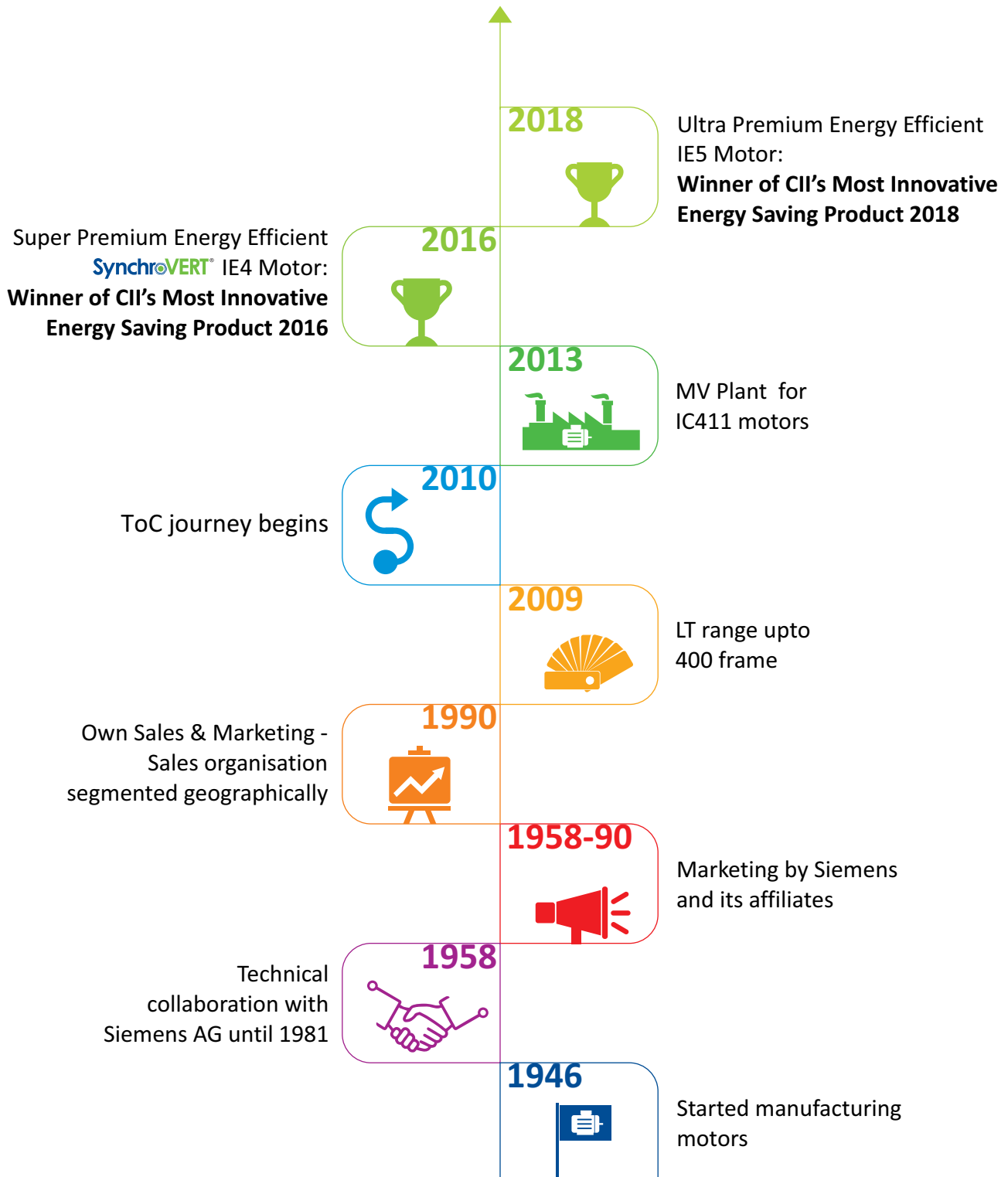

WHY BHARAT BIJLEE?



Preferred brand across multiple sectors like Cement, Construction, Steel, Food & Beverages, Water & Wastewater, and Sugar & Distilleries, to name a few.



Motors suited for all applications i.e. Pumps, Compressors, Fans & Blowers, Conveyors, Lifts, Screen, Vibrators, Centrifuges, Stone Crusher, and many more.



The most suitable solutions for extremely harsh and severe applications.



Customized motors designed and manufactured to suit application-specific needs.



Motors conform to relevant IS/IEC standards.



Annual production capacity over 4,20,000 motors.



Supply chain based on the concept of 'Theory of Constraints' ensures short lead times, reliable deliveries and superior availability.



Rigorous process control and quality assurance.



Pan India dealer and service network.

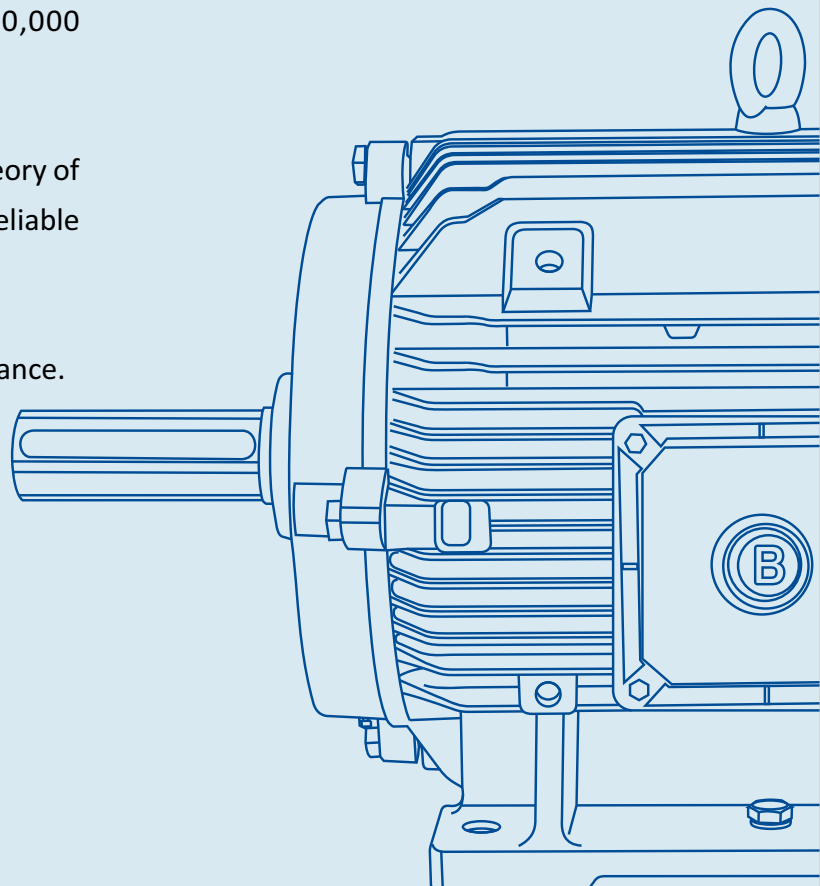

The industrial sector accounts for over half of the total electricity consumption, of which 60-70% is utilized by electric motors. This indicates that electric motors consume more energy than any other application.

A typical electric motor's average lifespan ranges anywhere between 15 to 20 years depending on the quality of raw material and manufacturing process. The operational cost of a motor is around 95% of the total life cycle cost. With a steadily increasing installed base of electric motors, our nation has a tremendous opportunity to save energy.

The purpose of energy efficiency labelling is to overcome the lack of awareness and also help end users in selecting from a range of energy-efficient products. While the developed world has kept pace with energy efficiency measures, developing countries have been slower to implement them for electric motors.

In the past, adhering to the Minimum Energy Performance

Standards (MEPS) was voluntary. However, as per the recent mandate by the Government of India, the minimum efficiency of three phase squirrel cage induction motors that can be manufactured and sold in the country needs to be IE2 efficiency level conforming to the IS standards.

Bharat Bijlee has always advocated the concept of energy saving for a sustainable future. It has always been our persistent endeavour to develop a wide range of motors in the premium efficiency series, thus rendering a choice to customers to select from the wide range of energy-efficient motors.

Established in 1946, Bharat Bijlee has evolved over the decades to provide a wide range of motors suitable even for the most severe of applications. Having gained the trust of our customers over the years, we continue to be the most preferred brand as a result of our unique offering to the industry.



A MOTOR FOR EVERY NEED

REFERENCE STANDARDS

IS 15999 Part 1	Three Phase Induction Motor specifications (“Rotating Electrical Machines - Part 1: Rating & Performance”)
IS : 900	Code of practice for installation & maintenance of Induction Motors
IS: 1231	Dimensions of foot mounted A.C Induction Motors
IS: 2223	Dimensions of flange mounted A.C Induction Motors
IS: 4029	Guide for testing of Three Phase Induction Motors (For Standard TEFC SCR Motors)
IS: 4889	Methods of determination of efficiency of Rotating Electrical Machines (For Standard TEFC SCR Motors)
IS/IEC 60034-5	Degree of protection provided by the integral design of Rotating Electrical Machines (IP Code Classification)
IS: 6362/IEC 60034-6	Designation of method of cooling for Rotating Electrical Machines / Method of cooling (IC Code)
IS:12065/IEC 60034-9	Permissible limits of noise level for Rotating Electrical Machines
IS : 12075	Mechanical Vibration of Rotating Electrical Machines
IS : 12615	Energy Efficient Induction Motors Three Phase Squirrel Cage
IEC 60034-30	Rotating Electrical Machines - Efficiency classes of line operated AC Motors (IE Code)
IEC 60072-1	Dimension & Output rating of Rotating Electrical Machines
IS:15999 (Part 2/Sec 1)	Standard Methods for determining losses and efficiency from tests (For IE Series Motors)

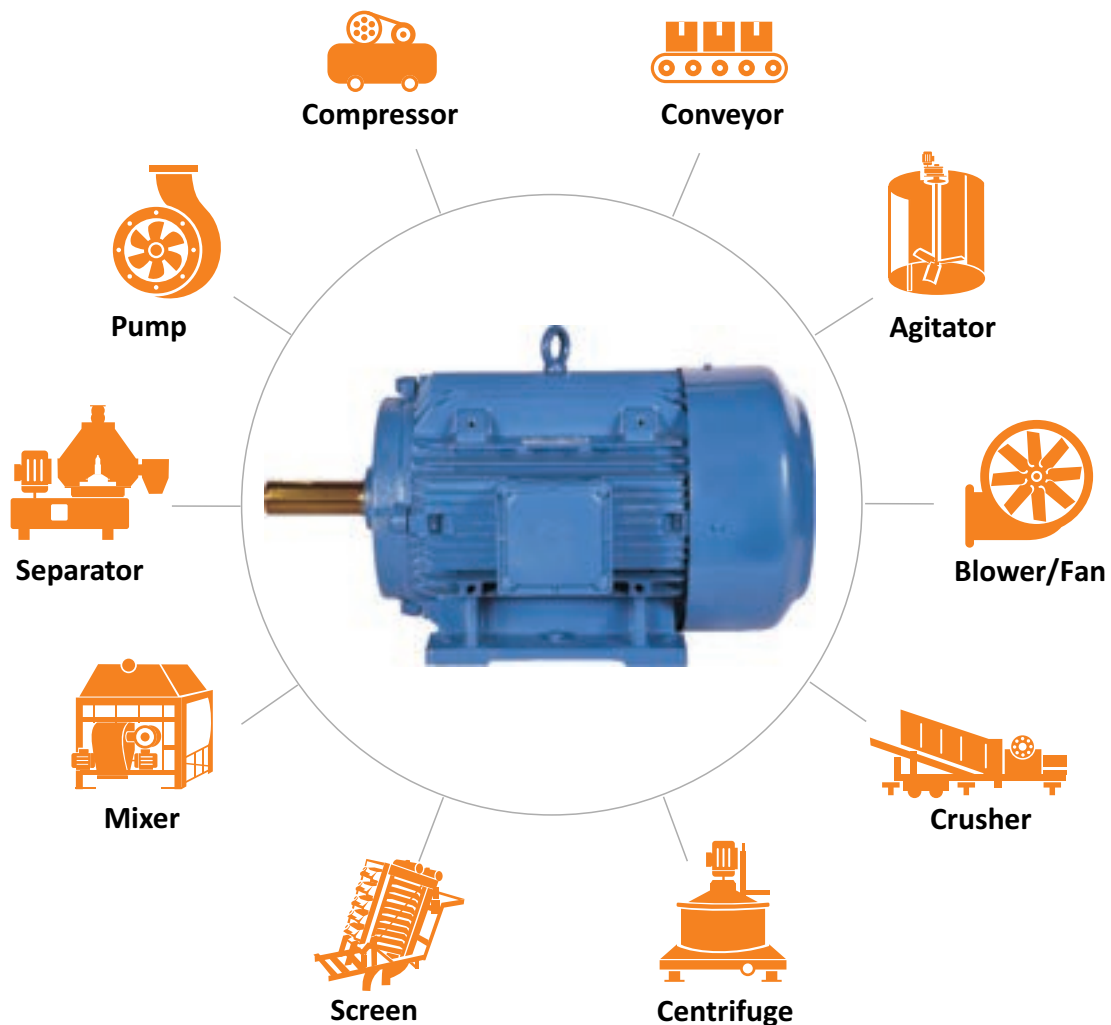



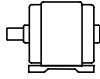
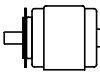
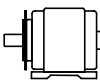
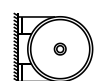
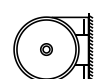
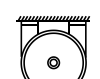
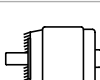

MOUNTING ARRANGEMENT

Base refers to baseplate, foundation, slide rails, pedestal, etc.

Horizontal Mounting

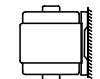
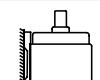
Symbol	Schematic Diagram	Frame	Mounting
B3 IMB3 / IM1001		With feet	Mounted on base
B5 IMB5 / IM3001		Without feet	Mounted on Type B flange with shaft extension at flange end
B35 IMB35 / IM2001		With feet	Mounted on base with feet, and on Type B flange with shaft extension at flange end
B6 IMB6 / IM1051		With feet	Mounted on base to the wall; feet towards the left when viewed from DE side
B7 IMB7 / IM1061		With feet	Mounted on base to the wall; feet towards the right when viewed from DE side
B8 IMB8 / IM1071		With feet	Mounted on base to the ceiling; feet at the top
B14 IMB14 / IM3601		Without feet	Mounted on Type C flange with shaft extension at flange end

Vertical Mounting

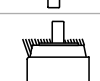
Symbol	Schematic Diagram	Frame	Mounting
V5 IMV5 / IM1011		With feet	Mounted on base to the wall; shaft downwards
V6 IMV6 / IM1031		With feet	Mounted on base to the wall; shaft upwards
V1 IMV1 / IM3011		Without feet	Mounted on Type B flange with shaft extension at flange end; shaft downwards
V3 IMV3 / IM3031		Without feet	Mounted on Type B flange with shaft extension at flange end; shaft upwards
V18 IMV18 / IM3611		Without feet	Mounted on Type C flange with extension at flange end; shaft downwards
V19 IMV19 / IM3631		Without feet	Mounted on Type C flange with shaft extension at flange end; shaft upwards

GENERAL TECHNICAL SPECIFICATIONS

Range

- **Series:** 3 Phase Squirrel Cage Induction, IE2 Safe Area Motors
- **kW Rating:** 0.12 to 355
- **Frame:** 56 to 355
- **Polarity:** 2, 4, 6 & 8



Standard Features	Optional Features
Voltage: 415V	Any other voltage on request
Frequency: 50 Hz	60 Hz
IP55	IP56, IP65, IP66
B3 Mounting	B5, B35 B14 (upto 132 Frame)
Ambient: 50°C ; For DCCA motors: 40°C	Any other on request
Altitude: up to 1000 m above mean sea level	Motors for higher altitudes on request
Top TB	Any other on request
Aluminium Construction: 56 to 132 Frame Cast Iron Construction: 160 Frame & Above	Cast Iron construction: 80 to 132 Frame
Insulation: Class F	Insulation: Class H
IC411: Totally Enclosed Fan Cooled	IC410: Natural Ventilation IC416: Forced Cooling for 132 Frame & above
Sealed Bearing: upto 200 Frame Online Greasing Arrangement: 225 Frame & Above	Online Greasing Arrangement: 160 to 200 Frame
Paint Shade: Acrylic base, RAL5000	Any other shade or material on request
Fan Cover: Steel	
Thermal Protection in DCCA Motors: 3 nos. simplex RTD	Duplex RTD: For DCCA Motors Simplex & duplex RTD: 250 Frame & Above BTD: 250 Frame & above Thermister: 80 Frame & Above
Space Heater for DCCA Motors	Space Heater: 90 Frame & Above
Inverter Duty Application: 315 Frame & Above	Inverter Duty Application: Upto 280 Frame
Packing: Thermocol / Corrugated Boxes: Upto 132 Frame Packing: Wooden Packing Boxes: 160 Frame & Above	Wooden Pallets Seaworthy / Export Packing Case
For standard bearings, kindly refer to the bearing chart	Insulated Bearing / Hybrid Bearing: 132 frame & above Cylindrical Roller Bearing with Locking Arrangement on DE Side : 160 frame & above

Our other optional features:

- Higher polarity
- Motors suitable for inverter duty application for all voltages
- Motors suitable for S2 to S9 duty operation
- VPI upto 280 frame
- Non standard shaft material, diameter & extension
- Front bearing locking arrangement
- SS Hardware, Canopy, non standard paint & paint shade, cable gland
- Provision for hollow shaft encoder mounting
- High temperature grease
- Reduced & Special grades of vibration as per IS 12075 can be provided on request

RE-RATING FACTORS APPLICABLE UNDER DIFFERENT CONDITIONS OF SUPPLY VOLTAGE, FREQUENCY, AMBIENT & ALTITUDE

I. Variation in Supply Voltage & Frequency

Voltage Variation %	Frequency Variation %	Combined Voltage & Frequency %	Permissible Output as % of Rated Value
± 10	± 5	± 10	100
± 12.5	± 5	± 12.5	95
± 15	± 5	± 15	90

II. Variation in Ambient

Ambient Temperature (°C)	Permissible Output as % of Rated Value
< 30	107
30 to 45	103
50	100
55	96
60	92

III. Variation in Altitude

Altitude Above Mean Sea Level (m)	Permissible Output as % of Rated Value
1000	100
1500	97
2000	94
2500	90
3000	86
3500	82
4000	77

Method of Starting:

kW Rating	Method of Starting	No. of Leads
Upto & including 1.5kW	DOL	6
Above 1.5kW	DOL or Star / Delta	6

Number of Consecutive Starts:

For continuous (S1) duty motors wherein load $GD^2 \leq$ Motor GD^2 , the motors can safely withstand 3 consecutive starts from cold condition & 2 consecutive starts from hot condition.

Starting Current Measurement of Bharat Bijlee Motors:

Induction motor starting current is generally 6 to 7 times the rated current of the motor. Starting current measurement may be carried out at reduced voltage due to capacity constraint and then extrapolated to the rated voltage. At Bharat Bijlee, the starting current measurement is done at reduced voltage as per the table below.

kW Range	Measurement at % of voltage to rated voltage
0.12kW to 90kW	70%
90kW to 200kW	60%
200kW to 355kW	35%
355kW to 560kW	25%
560kW and above (with rated voltage 690V or higher)	25%

Bearing Chart

Frame Size	Bearing Nos.	
	D.E.	N.D.E.
63	6201 2Z	6201 2Z
71	6202 2Z	6202 2Z
80	6004 2Z	6004 2Z
90S & L	6205 2Z	6205 2Z
100L	6206 2Z	6205 2Z
112M	6206 2Z	6205 2Z
132S / M	6208 2Z	6208 2Z
160M/L	6309 2Z	6209 2Z
180M/L	6310 2Z	6210 2Z
200L	6312 2Z	6212 2Z
225S/M	6313	6213
250M	6315	6215
280S/M (2 Pole)	6316	6316
280S/M (4,6,8 Pole)	6317	6316
315S/M & L	6319	6319
355L	6322	6322

LV MOTORS: IE2 SAFE AREA

Performance Data: Efficiency Values Complying to IE2 Efficiency Class of IS12615

Applicable standard for testing & efficiency determination: IS15999

Voltage: 415V +/- 10%

Frequency: 50Hz +/- 5%

Combined Variation: +/- 10%

Ambient: 50°C

Duty: S1 (Continuous)

3000 rpm (2 Pole)

Insulation: Class F

Temperature Rise: Class B

Protection: IP55

Rated Output		Frame size	Type Reference	Operating characteristics at rated output				With DOL starting				Rotor GD ²	Net Weight B3 constr.			
kW	HP			Rated Speed	Rated Current	Rated Torque	Power Factor	% Efficiency	Starting Current Ratio	Starting Torque Ratio	Pullout Torque Ratio			kgm ²	kg	
0.18	0.25	63	B3 construction	2700	0.58	0.06	0.72	0.65	0.50	60.4	54.0	3.5	2.3	2.5	0.0005	4.5
0.25	0.35	63	2H063213AT000	2700	0.75	0.09	0.72	0.65	0.50	64.8	60.0	3.5	2.4	2.6	0.0006	5
0.37	0.50	71	2H0712A3AT000	2800	0.95	0.13	0.78	0.70	0.53	69.5	64.0	4.0	2.0	3.0	0.0012	6.8
0.55	0.75	71	2H071233AT000	2820	1.36	0.19	0.76	0.64	0.50	74.1	65.0	5.0	2.5	2.8	0.0016	7.7
0.75	1.0	80	2H080213AT000	2840	1.66	0.26	0.81	0.73	0.60	77.4	76.4	5.0	2.2	2.5	0.0026	10
1.1	1.5	80	2H080233AT000	2855	2.37	0.38	0.81	0.75	0.61	79.6	79.6	5.5	2.7	3.0	0.0034	11
1.5	2.0	90S	2H09S243AT000	2835	3.09	0.52	0.83	0.77	0.66	81.3	80.0	6.0	2.6	2.8	0.0053	15
2.2	3.0	90L	2H09L273AT000	2835	4.33	0.76	0.85	0.80	0.70	83.2	82.5	6.0	2.8	3.0	0.0066	17
3.7	5.0	100L	2H10L233AT000	2890	6.84	1.25	0.88	0.83	0.73	85.5	83.0	6.5	2.8	3.1	0.0142	24
5.5	7.5	132S	2H13S2G3AT000	2930	9.88	1.83	0.89	0.86	0.79	87.0	84.5	6.5	2.5	3.0	0.0515	47
7.5	10	132S	2H13S2N3AT000	2935	13.3	2.49	0.89	0.86	0.80	88.1	86.0	6.5	2.5	3.0	0.0800	59
9.3	12.5	160M	2H16M233CT000	2940	16.5	3.08	0.88	0.86	0.81	88.9	86.0	6.0	2.0	2.5	0.142	98
11	15	160M	2H16M253CT000	2940	19.5	3.64	0.88	0.85	0.79	89.4	87.0	6.5	2.1	2.6	0.160	104
15	20	160M	2H16M263CT000	2940	26.3	4.97	0.88	0.87	0.82	90.3	88.0	6.5	2.0	2.5	0.191	115
18.5	25	160L	2H16L293CT000	2940	31.5	6.13	0.90	0.89	0.86	90.9	89.0	6.5	2.0	2.5	0.244	137
22	30	180M	2H18M233CT000	2940	38.5	7.29	0.87	0.84	0.78	91.3	90.0	6.5	2.4	2.7	0.325	171
30	40	200L	2H20L2A3CT000	2950	51.6	9.91	0.88	0.86	0.80	92.0	90.5	6.5	2.6	3.0	0.524	259
37	50	200L	2H20L273CT000	2955	64.7	12.2	0.86	0.83	0.75	92.5	91.0	6.5	2.6	3.0	0.573	272
45	60	225M	2H22M253CT000	2965	77.5	14.8	0.87	0.85	0.80	92.9	91.5	6.5	2.3	2.4	1.04	365
55	75	250M	2H25M233CT000	2970	92.2	18.0	0.89	0.87	0.81	93.2	91.0	6.5	2.3	2.7	1.45	487
75	100	280S	2H28S23300000	2970	122	24.6	0.91	0.89	0.86	93.8	92.0	6.5	2.0	2.8	3.01	669
90	120	280M	2H28M25300000	2970	146	29.5	0.91	0.89	0.86	94.1	93.9	6.5	2.0	2.8	3.42	750
110	150	315S	2H31S23300000	2982	180	35.9	0.90	0.86	0.80	94.3	91.5	7.0	2.2	2.5	5.00	940
125	170	315M	2H31M2A300000	2982	207	40.8	0.89	0.85	0.78	94.5	91.5	7.0	2.2	2.6	5.00	940
132	180	315M	2H31M23300000	2982	216	43.1	0.90	0.86	0.80	94.6	91.3	7.0	2.0	2.5	5.00	940
150	200	315L	2H31L2A300000	2982	248	49.0	0.89	0.84	0.78	94.7	92.2	7.0	2.0	2.5	6.20	1100
160	215	315L	2H31L25300000	2985	261	52.2	0.90	0.86	0.80	94.8	93.0	7.0	2.4	2.5	6.20	1100
180	240	315L	2H31L2B300000	2982	300	58.8	0.88	0.82	0.75	94.9	93.0	7.0	2.0	2.5	7.70	1390
200	270	355L	2H35L2A300000	2985	325	65.3	0.90	0.87	0.82	95.0	92.2	7.0	1.6	2.4	12.0	1680
250	335	355L	2H35L21300000	2985	407	81.6	0.90	0.88	0.84	95.0	92.8	7.0	1.6	2.4	12.0	1680
315	425	355L	2H35L23300000	2985	513	103	0.90	0.88	0.84	95.0	93.0	7.0	1.6	2.4	14.7	1870

Note: All performance values are subject to tolerances as per IS 15999: Part-1

LV MOTORS: IE2 SAFE AREA

Performance Data: Efficiency Values Complying to IE2 Efficiency Class of IS12615

Applicable standard for testing & efficiency determination : IS15999

Voltage: 415V +/- 10%

Frequency: 50Hz +/- 5%

Combined Variation: +/- 10%

Ambient: 50°C

Duty: S1 (Continuous)

1500 rpm (4 Pole)

Insulation: Class F
Temperature Rise: Class B
Protection: IP55

Rated Output		Frame size	Type Reference	Operating characteristics at rated output						With DOL starting			Rotor GD ² kgm ²	Net Weight B3 constr. kg			
kW	HP			Rated Speed RPM	Rated Current Amps.	Rated Torque kg-m	Power Factor			% Efficiency	Starting Current to Rated Current Ratio	Starting Torque to Rated Torque Ratio			Pullout Torque to Rated Torque Ratio		
			B3 construction	FL	3/4L	1/2L	FL	3/4L	1/2L	FL	3/4L	1/2L					
0.12	0.16	63	2H063413AT000	0.39	0.73	0.62	0.48	0.59	59.1	59.1	59.1	53.0	2.5	1.7	2.0	0.0010	4.5
0.18	0.25	63	2H063433AT000	0.54	0.72	0.62	0.50	64.7	64.7	64.7	59.0	3.0	1.7	2.0	0.0013	5.5	
0.25	0.35	71	2H0714A3AT000	0.72	0.71	0.61	0.45	68.5	68.5	68.5	60.0	3.5	1.7	1.9	0.0022	6.8	
0.37	0.50	71	2H071433AT000	1.00	0.68	0.58	0.47	72.7	72.7	72.7	70.0	3.5	2.0	2.2	0.0031	8	
0.55	0.75	80	2H080433AT000	1.34	0.74	0.64	0.50	77.1	77.1	77.1	72.0	5.0	2.8	3.0	0.0066	10	
0.75	1.0	80	2H080453AT000	1.70	0.77	0.67	0.55	79.6	79.6	79.6	76.0	5.0	2.8	3.0	0.0073	11	
1.1	1.5	90S	2H09S423AT000	2.41	0.78	0.69	0.55	81.4	81.4	81.4	79.0	5.5	2.3	2.7	0.0097	14	
1.5	2.0	90L	2H09L473AT000	3.23	0.78	0.68	0.56	82.8	82.8	82.8	80.5	5.5	2.5	2.8	0.013	17	
2.2	3.0	100L	2H10L473AT000	4.37	0.83	0.74	0.60	84.3	84.3	84.3	82.5	6.0	2.6	3.0	0.021	24	
3.7	5.0	112M	2H11M473AT000	7.36	0.81	0.76	0.64	86.3	86.3	86.3	85.0	6.0	2.6	3.0	0.049	32	
5.5	7.5	132S	2H13S4K3AT000	10.4	0.84	0.81	0.67	87.7	87.7	87.7	86.0	6.5	2.2	2.8	0.103	48	
7.5	10	132M	2H13M4T3AT000	14.0	0.84	0.76	0.65	88.7	88.7	88.7	87.0	6.5	2.3	2.8	0.125	57	
9.3	12.5	160M	2H16M4C3CT000	17.6	0.82	0.76	0.68	89.4	89.4	89.4	87.0	6.5	2.4	2.7	0.187	99	
11	15	160M	2H16M4K3CT000	20.5	0.83	0.78	0.68	89.8	89.8	89.8	88.5	6.5	2.4	2.7	0.224	109	
15	20	160L	2H16L4T3CT000	27.8	0.83	0.78	0.68	90.6	90.6	90.6	89.5	6.5	2.4	2.7	0.293	132	
18.5	25	180M	2H18M473CT000	33.6	0.84	0.80	0.70	91.2	91.2	91.2	90.5	6.0	2.6	2.9	0.467	168	
22	30	180L	2H18L483CT000	39.3	0.85	0.82	0.72	91.6	91.6	91.6	91.0	6.5	2.6	2.9	0.532	187	
30	40	200L	2H20L453CT000	54.5	0.83	0.79	0.68	92.3	92.3	92.3	90.5	7.0	2.6	2.6	1.07	267	
37	50	225S	2H22S433CT000	65.3	0.85	0.82	0.75	92.7	92.7	92.7	91.0	6.0	2.3	2.4	1.41	330	
45	60	225M	2H22M453CT000	79.1	0.85	0.82	0.74	93.1	93.1	93.1	91.0	6.5	2.4	2.5	1.67	362	
55	75	250M	2H25M433CT000	96.3	0.85	0.82	0.74	93.5	93.5	93.5	92.5	6.5	2.5	2.7	2.95	500	
75	100	280S	2H28S423CT000	129	0.86	0.83	0.76	94.0	94.0	94.0	93.0	6.5	2.4	2.6	6.00	670	
90	120	280M	2H28M453CT000	155	0.86	0.82	0.76	94.2	94.2	94.2	93.5	6.5	2.3	2.8	6.87	725	
110	150	315S	2H31S413CT000	191	0.85	0.82	0.72	94.5	94.5	94.5	93.2	6.5	2.5	3.0	9.04	900	
125	170	315M	2H31M4A3CT000	216	0.85	0.80	0.73	94.7	94.7	94.7	93.5	6.8	2.25	2.75	10.7	970	
132	180	315M	2H31M433CT000	225	0.86	0.83	0.76	94.7	94.7	94.7	94.0	6.5	2.25	2.75	10.7	970	
150	200	315L	2H31L4A3CT000	259	0.85	0.83	0.76	94.9	94.9	94.9	94.0	6.8	2.5	3.0	13.3	1165	
160	215	315L	2H31L453CT000	273	0.86	0.84	0.78	94.9	94.9	94.9	94.0	6.5	2.4	3.0	13.3	1165	
180	240	315L	2H31L463CT000	307	0.86	0.84	0.78	95.0	95.0	95.0	94.5	6.5	2.4	3.0	1230	1230	
200	270	315L	2H31L473CT000	336	0.87	0.84	0.78	95.1	95.1	95.1	94.0	6.5	2.4	3.0	17.0	1320	
250	335	355L	2H35L41300000	416	0.88	0.85	0.75	95.1	95.1	95.1	94.9	6.5	2.2	2.5	23.3	1680	
315	425	355L	2H35L43300000	524	0.88	0.85	0.75	95.1	95.1	95.1	93.5	6.5	2.2	2.5	32.7	1855	
355	475	355L	2H35L45300000	590	0.88	0.85	0.75	95.1	95.1	95.1	93.5	6.5	2.2	2.5	37.9	2186	

Note: All performance values are subject to tolerance as per IS 15999; Part-1

LV MOTORS: IE2 SAFE AREA

Performance Data: Efficiency Values Complying to IE2 Efficiency Class of IS12615

Applicable standard for testing & efficiency determination : IS15999
 Voltage: 415V +/- 10%
 Frequency: 50Hz +/- 5%
 Combined Variation: +/- 10%

Ambient: 50°C
 Duty: S1 (Continuous)
 1000 rpm (6 Pole)

Insulation: Class F
 Temperature Rise: Class B
 Protection: IP55

Rated Output		Frame size	Type Reference	Operating characteristics at rated output				With DOL starting				Rotor	Net Weight			
kW	HP		B3 construction	Rated Speed	Rated Current	Rated Torque	Power Factor			% Efficiency	Starting Current Ratio	Starting Torque to Rated Torque Ratio	Pullout Torque to Rated Torque Ratio	GD ²	B3 constr.	
				RPM	Amps.	kg-m	FL	3/4L	1/2L	FL	3/4L	1/2L	FL	3/4L	1/2L	kg
0.18	0.25	71	2H0716A3AT000	880	0.63	0.20	0.70	0.60	0.50	0.50	56.6	56.6	56.6	0.0033	7.2	
0.25	0.35	71	2H0716B3AT000	860	0.78	0.28	0.72	0.62	0.50	0.50	61.6	61.6	61.6	0.0033	7.2	
0.37	0.5	80	2H080613AT000	910	1.06	0.40	0.72	0.62	0.50	0.50	67.6	67.6	67.6	0.0054	8	
0.55	0.75	80	2H080633AT000	910	1.45	0.59	0.72	0.63	0.50	0.50	73.1	73.1	73.1	0.0078	10	
0.75	1.0	90S	2H09S633AT000	920	1.90	0.79	0.72	0.61	0.50	0.50	75.9	75.9	75.9	0.0105	14	
1.1	1.5	90L	2H09L653AT000	920	2.72	1.16	0.72	0.61	0.50	0.50	78.1	78.1	78.1	0.0155	17	
1.5	2.0	100L	2H10L633AT000	935	3.63	1.56	0.72	0.62	0.52	0.52	79.8	79.8	79.8	0.0241	22	
2.2	3.0	112M	2H11M653AT000	955	5.00	2.24	0.75	0.65	0.56	0.56	81.8	81.8	81.8	0.0609	32	
3.7	5.0	132S	2H13S6G3AT000	960	7.83	3.75	0.78	0.73	0.60	0.60	84.3	84.3	84.3	0.109	46	
5.5	7.5	132M	2H13M6T3AT000	960	11.6	5.58	0.77	0.71	0.60	0.60	86.0	86.0	86.0	0.152	59	
7.5	10	160M	2H16M633CT000	965	15.3	7.57	0.78	0.73	0.62	0.62	87.2	87.2	87.2	0.217	97	
9.3	12.5	160L	2H16L663CT000	965	18.6	9.39	0.79	0.74	0.64	0.64	88.0	88.0	88.0	0.289	115	
11	15	160L	2H16L673CT000	965	22.1	11.1	0.78	0.73	0.62	0.62	88.7	88.7	88.7	0.319	120	
15	20	180L	2H18L633CT000	975	28.4	15.0	0.82	0.78	0.68	0.68	89.7	89.0	89.0	0.740	183	
18.5	25	200L	2H20L633CT000	975	34.7	18.5	0.82	0.77	0.69	0.69	90.4	89.5	89.5	1.10	242	
22	30	200L	2H20L653CT000	975	41.1	22.0	0.82	0.77	0.69	0.69	90.9	89.5	89.5	1.30	260	
30	40	225M	2H22M643CT000	980	52.3	29.8	0.87	0.84	0.76	0.76	91.7	90.0	90.0	2.41	355	
37	50	250M	2H25M633CT000	980	63.4	36.8	0.88	0.85	0.78	0.78	92.2	91.8	91.8	3.25	500	
45	60	280S	2H28S613CT000	983	80.4	44.6	0.84	0.81	0.73	0.73	92.7	92.6	92.6	4.68	580	
55	75	280M	2H28M633CT000	983	96.7	54.5	0.85	0.82	0.75	0.75	93.1	92.8	92.8	6.18	640	
75	100	315S	2H31S613CT000	988	133	73.9	0.84	0.80	0.72	0.72	93.7	93.2	93.2	9.64	836	
90	120	315M	2H31M633CT000	990	159	88.6	0.84	0.80	0.72	0.72	94.0	93.5	93.5	11.4	900	
110	150	315M	2H31M653CT000	990	193	108	0.84	0.79	0.70	0.70	94.3	93.5	93.5	14.8	1021	
125	170	315L	2H31L6A3CT000	990	222	123	0.83	0.79	0.70	0.70	94.5	93.5	93.5	17.3	1228	
132	180	315L	2H31L673CT000	990	231	130	0.84	0.80	0.72	0.72	94.6	94.0	94.0	17.3	1228	
150	200	315L	2H31L683CT000	993	265	147	0.83	0.79	0.70	0.70	94.7	94.4	94.4	20.4	1340	
160	215	315L	2H31L693CT000	993	280	157	0.84	0.80	0.72	0.72	94.8	94.5	94.5	20.4	1340	
180	240	355L	2H35L6A300000	990	322	177	0.82	0.77	0.65	0.65	94.9	93.3	93.3	28.7	1670	
200	270	355L	2H35L61300000	990	349	197	0.84	0.80	0.70	0.70	95.0	93.5	93.5	28.7	1670	
250	335	355L	2H35L63300000	990	436	246	0.84	0.80	0.70	0.70	95.0	93.4	93.4	35.5	1780	

Note: All performance values are subject to tolerance as per IS 15999: Part-1

LV MOTORS: IE2 SAFE AREA

Performance Data: Efficiency Values Complying to IE2 Efficiency Class of IS12615

Applicable standard for testing & efficiency determination : IS15999
 Voltage: 415V +/- 10%
 Frequency: 50Hz +/- 5%
 Combined Variation: +/- 10%

Ambient: 50°C
 Duty: S1 (Continuous)
 750 rpm (8 Pole)

Insulation: Class F
 Temperature Rise: Class B
 Protection: IP55

Rated Output		Frame size	Type Reference	Operating characteristics at rated output						With DOL starting			Rotor GD ² kgm ²	Net Weight B3 constr. kg			
kW	HP			Rated Speed RPM	Rated Current Amps.	Rated Torque kg-m	Power Factor			% Efficiency	Starting Current to Rated Current Ratio	Starting Torque to Rated Torque Ratio			Pullout Torque to Rated Torque Ratio		
			B3 construction			FL	3/4L	1/2L	FL	3/4L	1/2L						
0.12	0.16	71	2H071833AT000	640	0.76	0.18	0.55	0.40	0.55	0.50	0.40	39.8	2.2	1.7	2.1	0.0033	7
0.18	0.25	80	2H080813AT000	675	0.91	0.26	0.60	0.42	0.60	0.52	0.42	45.9	3.0	1.8	2.2	0.0054	8
0.25	0.35	80	2H080833AT000	675	1.11	0.36	0.62	0.45	0.62	0.55	0.45	50.6	3.0	1.8	2.2	0.0078	10
0.37	0.50	90S	2H095813AT000	680	1.30	0.53	0.71	0.58	0.71	0.58	0.46	56.1	2.8	1.7	2.1	0.0097	12
0.55	0.75	90L	2H09L853AT000	680	1.82	0.79	0.68	0.60	0.68	0.60	0.46	61.7	2.8	1.7	2.1	0.0129	14
0.75	1.0	100L	2H10L813AT000	685	2.25	1.07	0.70	0.61	0.70	0.61	0.50	66.2	3.0	1.9	2.3	0.0216	18
1.1	1.5	100L	2H10L833AT000	680	3.09	1.58	0.70	0.61	0.70	0.61	0.50	70.8	3.0	1.9	2.3	0.0271	20
1.5	2.0	112M	2H11M813AT000	695	4.00	2.10	0.70	0.61	0.70	0.61	0.49	74.1	3.8	1.7	2.2	0.0500	25
2.2	3.0	132S	2H13S883AT000	705	5.33	3.04	0.74	0.66	0.74	0.66	0.55	77.6	3.8	1.7	2.2	0.0911	41
3.7	5.0	160M	2H16M813CT000	715	8.55	5.04	0.74	0.68	0.74	0.68	0.55	81.4	4.4	1.7	2.2	0.202	87
5.5	7.5	160M	2H16M833CT000	715	12.2	7.49	0.75	0.68	0.75	0.68	0.55	83.8	4.4	1.7	2.2	0.291	101
7.5	10	160L	2H16L863CT000	715	16.3	10.2	0.75	0.70	0.75	0.70	0.58	85.3	4.4	1.8	2.3	0.376	119
9.3	12.5	180M	2H18M833CT000	725	19.5	12.5	0.77	0.74	0.77	0.74	0.64	86.3	5.0	1.7	2.1	0.705	170
11	15	180L	2H18L873CT000	725	22.9	14.8	0.77	0.74	0.77	0.74	0.64	86.9	5.0	1.8	2.2	0.813	187
15	20	200L	2H20L843CT000	725	28.9	20.2	0.82	0.77	0.82	0.77	0.65	88.0	5.5	2.3	2.5	1.37	264
18.5	25	225S	2H22S823CT000	725	35.4	24.9	0.82	0.80	0.82	0.80	0.72	88.6	5.5	2.0	2.2	2.11	324
22	30	225M	2H22M833CT000	725	41.9	29.6	0.82	0.80	0.82	0.80	0.72	89.1	5.5	2.0	2.2	2.41	351
30	40	250M	2H25M813CT000	730	56.7	40.0	0.82	0.80	0.82	0.80	0.72	89.8	5.5	2.0	2.2	3.25	498
37	50	280S	2H28S823CT000	730	73.1	49.4	0.78	0.74	0.78	0.74	0.65	90.3	5.5	2.0	2.2	6.18	641
45	60	280M	2H28M853CT000	738	90.8	59.4	0.76	0.72	0.76	0.72	0.60	90.7	5.5	2.0	2.2	7.25	690
55	75	315S	2H31S813CT000	739	112.1	72.5	0.75	0.72	0.75	0.72	0.62	91.0	5.5	1.8	2.0	9.6	836
75	100	315M	2H31M833CT000	739	154	98.8	0.74	0.70	0.74	0.70	0.62	91.6	5.5	1.8	2.0	11.4	900
90	120	315M	2H31M853CT000	741	179	118.3	0.76	0.72	0.76	0.72	0.64	91.9	5.5	1.8	2.0	14.8	1021
110	150	315L	2H31L873CT000	742	224	144.4	0.74	0.69	0.74	0.69	0.58	92.3	5.5	2.0	2.2	17.3	1228
125	170	315L	2H31L8A3CT000	742	247	164.1	0.76	0.70	0.76	0.70	0.60	92.5	5.5	2.0	2.2	21.5	1375
132	180	315L	2H31L893CT000	742	261	173.3	0.76	0.72	0.76	0.72	0.62	92.6	5.5	2.0	2.2	21.5	1375

Note: All performance values are subject to tolerance as per IS 15999: Part-1

DIMENSIONAL DRAWING: IE2 EFFICIENCY SERIES FOR SAFE AREA APPLICATION FOOT MOUNTED (IM B3/IM 1001) MOTORS

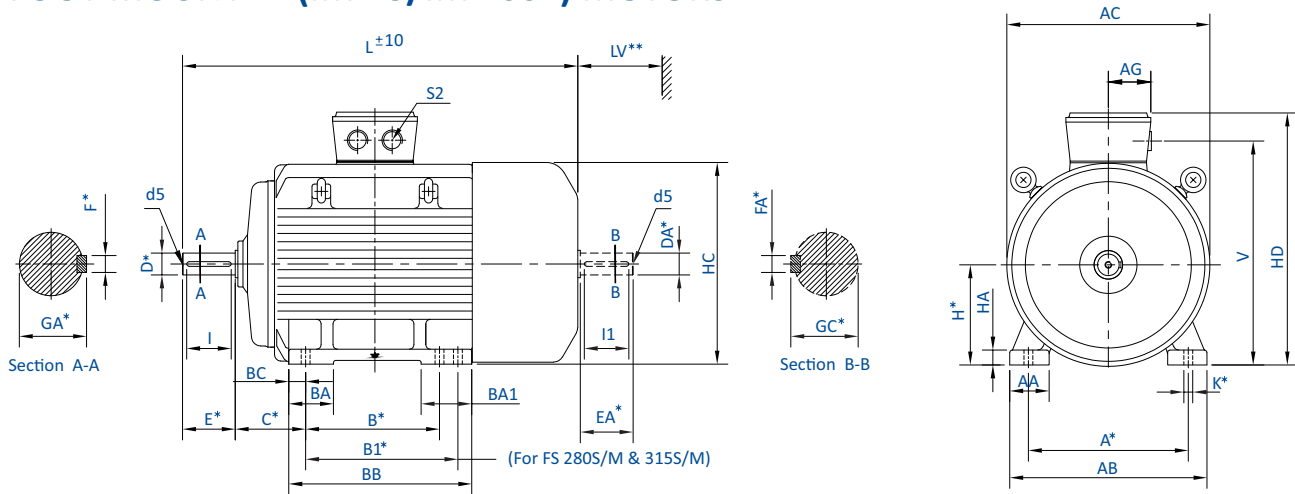

IEC Fr. Size	Pole	FIXING						GENERAL										TERMINAL BOX				SHAFT							
		A*	B*	B1*	C*	H*	K*	AB	BB	AA	BA	BA1	BC	HA	HC	HD	L	LV**	AC	V	AG	S2 BSC	D* DA*	E* EA*	F* FA*	GA* GC*	I	d5	
63	2,4	100	80	—	40	63	7	126	100	28	30	—	10	7	125	179	206	30	124	149	40	1x 3/4"	11	23	4	12.5	18	M4	
71	2,4,6&8	112	90	—	45	71	7	135	110	31	30	—	10	7	141	195	234	30	140	166	40	1x 3/4"	14	30	5	16	25	M5	
80	2,4,6&8	125	100	—	50	80	10	150	124	31	35	—	12	9	159	214	267	30	157	185	40	1x 3/4"	19	40	6	21.5	35	M6	
90S	2,4,6&8	140	100	—	56	90	10	168	125	34	31.5	—	13	12	177	230	302	35	174	199	52	2x 3/4"	24	50	8	27	45	M8	
90L	2,4,6&8	140	125	—	56	90	10	168	150	34	31.5	—	13	12	177	230	327	35	174	199	52	2x 3/4"	24	50	8	27	45	M8	
100L	2,4,6&8	160	140	—	63	100	12	190	174	43.5	36	—	17	12	198	257	366	40	195	225	56	2x 1"	28	60	8	31	55	M10	
112M	4,6&8	190	140	—	70	112	12	220	174	47	36	—	17	12	222	282	388	45	220	246	56	2x 1"	28	60	8	31	55	M10	
132S	2(7.5kW)	216	140	—	89	132	12	256	180	54	50	—	20	16	262	328	518	50	260	291	63	2x1"	38	80	10	41	70	M12	
	2&4																475												
	6&8																459												
132M	4	178	—	—	—	—	—	—	—	—	—	—	—	—	—	—	513	—	—	—	—	—	—	—	—	—	—	—	—
	6																497												
	—																635												
160M	2(15kW)	254	210	—	108	160	15	310	250	58	70	—	20	20	318	383	605	60	316	346	63	2x1"	42	110	12	45	105	M16	
	2																679												
	4,6&8																629												
160L	2&4	254	—	—	—	—	—	—	—	—	—	—	—	—	—	—	679	—	—	—	—	—	—	—	—	—	—	—	—
	6&8																679												
	—																679												
180M	2,4&8	279	241	—	121	180	15	344	281	65	70	—	20	26	357	451	717	70	354	396	97	2x1 1/2"	48	110	14	51.5	100	M16	
180L	4,6&8	279	279	—	121	180	15	344	319	65	70	—	20	26	357	451	717	70	354	396	97	2x1 1/2"	48	110	14	51.5	100	M16	
200L	2	318	305	—	133	200	19	398	355	85	85	—	25	32	397	519	795	80	394	449	155	2x2"	55	110	16	59	100	M20	
	4,6&8																772												
	—																827												
225S	4,8	356	286	—	149	225	19	436	336	85	85	—	25	34	450	568	837	90	445	500	155	2x2"	60	140	18	64	130	M20	
	—																855												
	2																855												
225M	2	311	—	—	—	—	—	—	—	—	—	—	—	—	—	—	837	—	—	—	—	—	—	—	—	—	—	—	—
	4,6&8																855												
	—																855												
250M	2	406	349	—	168	250	24	506	425	100	115	—	46	42	495	665	914	100	489	578	243	2x2"	60	140	18	64	130	M20	
	4,6&8																914												
	—																914												
280S/M	2	457	368	419	190	280	24	540	490	100	110	149	37	42	552	725	1010	115	544	638	243	2x 2"	65	140	18	69	130	M20	
	4,6&8																1010												
	—																1010												
315S/M	2	508	406	457	216	315	28	625	540	120	120	155	43	45	617	834	1175	130	604	728	278	2x2"	65	140	18	69	130	M20	
	4,6&8																1167												
	—																1340												
315L	2	508	—	—	—	—	—	—	—	—	—	—	—	—	—	—	1332	—	—	—	—	—	—	—	—	—	—	—	
	4,6&8																1461												
	—																1575												
355L	2	610	630	—	254	355	28	710	770	110	170	—	70	45	703	939	1575	145	695	850	403	2x3"	100	210	28	106	200	M24	
	4(355kW)																1531												
	4&6																1531												

Notes: * This is a mandatory dimension for all standard motors
 **Minimum distance for efficient cooling of motor to be maintained by user
 1. All dimensions are in mm unless otherwise specified
 2. Tolerances on mandatory dimensions are as per IS: 1231
 3. For non standard motors, dimensions may change. Please contact our nearest sales office for details

Notes: 1. Eyebolt is not provided in motors of 63 to 90 frame
 2. Shaft extension at NDE identical to standard shaft extension at DE is not possible in 4, 6 & 8 pole in frames 315L & 355L
 3. TB Position: To be read as: when viewed from DE side / when viewed parallel to the shaft / cable entry
(a) 63 frame, 160 to 225 frame: Top / Center of body / RHS when viewed from DE side
(b) 71 to 132 frame & 250 to 355 frame: Top / Towards Drive End / RHS when viewed from DE side

DIMENSIONAL DRAWING: IE2 EFFICIENCY SERIES FOR SAFE AREA APPLICATION FLANGE MOUNTED (IM B5/IM3001) MOTORS

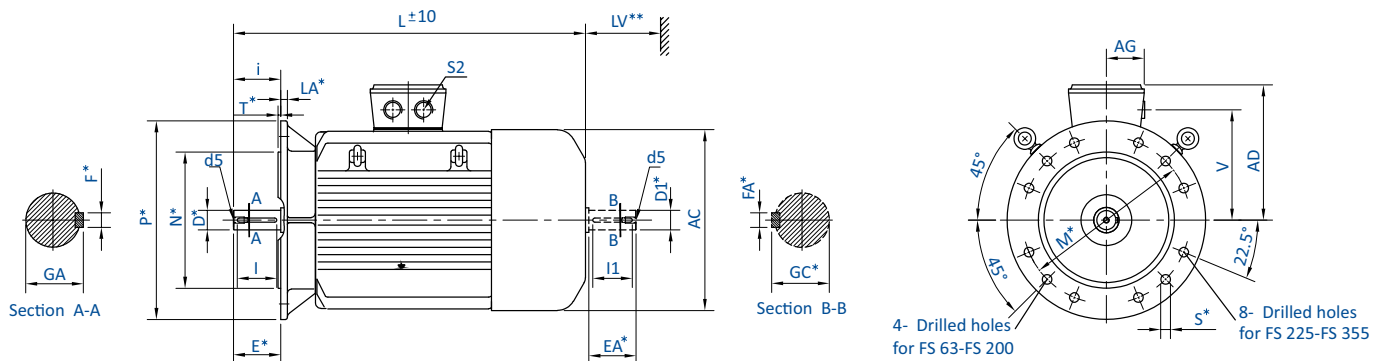

IEC Fr. Size	Pole	FIXING						GENERAL					TERMINAL BOX			SHAFT					
		P^*	N^*	M^*	i	S^*	T^*	LA^*	AD	L	LV^{**}	AC	V	AG	$S2$	BSC	$D^* DA^*$	$E^* EA^*$	$F^* FA^*$	$GA^* GC^*$	$I I1$
63	2,4	140	95	115	23	10	3	9	116	225	30	124	86	40	1x3/4"	11	23	4	12.5	18	M4
71	2,4,6&8	160	110	130	30	10	3.5	9	124	262	30	140	95	40	1x3/4"	14	30	5	16	25	M5
80	2,4,6&8	200	130	165	40	12	3.5	10	134	267	30	157	105	40	1x3/4"	19	40	6	21.5	35	M6
90S	2,4,6&8	200	130	165	50	12	3.5	10	140	302	35	174	109	52	2x3/4"	24	50	8	27	45	M8
90L	2,4,6&8									327											
100L	2,4,6&8	250	180	215	60	15	4	11	157	366	40	195	125	56	2x1"	28	60	8	31	55	M10
112M	4,6&8	250	180	215	60	15	4	11	170	388	45	220	134	56	2x1"	28	60	8	31	55	M10
132S	2(7.5kW)	300	230	265	80	15	4	12	196	518	50	260	159	63	2x1"	38	80	10	41	70	M12
	2&4									475											
	6&8									459											
132M	4	350	250	300	110	19	5	13	223	513	60	316	186	63	2x1"	42	110	12	45	105	M16
	6									497											
	2(15kW)									635											
160M	2	400	300	350	140	19	5	15	319	605	80	394	249	155	2x2"	55	110	16	59	100	M20
	4,6&8									585											
	2&4									679											
160L	6&8	450	350	400	140	19	5	16	343	629	90	445	275	155	2x2"	60	140	18	64	130	M20
	2									679											
	4,6&8									855											
180M	2,4&8	550	450	500	140	19	5	18	415	679	100	489	328	243	2x2"	65	140	18	69	130	M20
	4,6&8									717											
	2									795											
200L	4,6&8	550	450	500	140	19	5	18	445	772	115	544	358	243	2x2"	75	140	20	79.5	130	M20
	2									827											
	4&8									877											
225S	2	660	550	600	140	24	6	22	519	837	130	604	413	278	2x2"	65	140	18	69	130	M20
	4,6&8									855											
	2									1175											
225M	2	800	680	740	210	24	6	25	584	1167	145	695	495	403	2x3"	100	210	28	106	200	M24
	4,6&8									1340											
	2									1461											
250M	2	800	680	740	210	24	6	25	584	1575	145	695	495	403	2x3"	100	210	28	106	200	M24
	4,6&8									1531											
	2									1531											
280S/M	2	800	680	740	210	24	6	25	584	1575	145	695	495	403	2x3"	100	210	28	106	200	M24
	4,6&8									1531											
	2									1531											
315S/M	2	800	680	740	210	24	6	25	584	1575	145	695	495	403	2x3"	100	210	28	106	200	M24
	4,6&8									1531											
	2									1531											
315L	2	800	680	740	210	24	6	25	584	1575	145	695	495	403	2x3"	100	210	28	106	200	M24
	4,6&8									1531											
	2									1531											
355L	4(355kW)	800	680	740	210	24	6	25	584	1575	145	695	495	403	2x3"	100	210	28	106	200	M24
	4&6									1531											
	2									1531											

Notes: * This is a mandatory dimension for all standard motors
 **Minimum distance for efficient cooling of motor to be maintained by user
 1. All dimensions are in mm unless otherwise specified
 2. Tolerances on mandatory dimensions are as per IS: 2223
 3. For non standard motors, dimensions may change. Please contact our nearest sales office for details







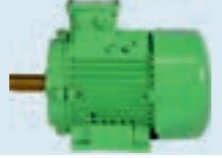

Notes: 1. Eyebolt is not provided in motors of 63 to 90 frame
 2. Shaft extension at NDE identical to standard shaft extension at DE is not possible in 4, 6 & 8 pole in frames 315L & 355L
 3. TB Position: To be read as: when viewed parallel to the shaft / cable entry
(a) 63 frame, 160 to 225 frame: Center of body / RHS when viewed from DE side
(b) 71 to 132 frame & 250 to 355 frame: Towards Drive End / RHS when viewed from DE side

LV MOTORS PRODUCT RANGE

Motors conform to relevant Indian Standards IS/IEC 60034 series

Voltage: 415V +/- 10%, Frequency: 50 Hz +/- 5%, Combined Variation: +/- 10%

Insulation: Class 'F' with temperature rise limited to Class 'B', Rotation: Bi-directional
Cooling: IC411, Degree of Protection: IP55, Altitude: Upto 1000m above MSL

Motor Type	Frame	Power (kW)	Polarity		Standard Technical Specifications	Optional Features	Applications	
IE2 Motors	56 to 355	0.12 to 355	2, 4, 6, 8		<ul style="list-style-type: none"> Ambient: 50° C Ambient for DCCA: 40° C Inverter Grade Winding: For IE3 and DCCA Duty: S1 RTD & BTD: For DCCA motors Mounting: B3, B5, B35, V1, B14 upto 132 Frame 	<ul style="list-style-type: none"> Non Standard Voltage: upto 690V Higher Polarity on request Insulation: Class H Space Heater: 90 Frame onwards RTD & BTD: 250 Frame onwards PTC Thermistor: 80 to 355L Shaft Material: EN24* Enclosure: IP56 / 65 / 66 Forced Cooling: 132 to 450 Frame Roller Bearing: 160 Frame onwards 	<ul style="list-style-type: none"> High Temperature Grease: Suitable up to 200° C SS Hardware Non standard shaft diameter/extension* Non Standard Paint Provision for Encoder Mounting Low Vibration as per IS or IEC Insulated Bearing: 132 Frame onwards SPM Nipples Provision: Frame 250 onwards 	Pump, Fan, Compressor, Packing Machinery, Coiler/De-coiler, Agro Equipment, Food Processing Equipment, Paper Machinery, Agitator, Dairy Equipment, Machine Tool, Air Conditioning, Material Handling, Plastic Machinery, Textile Machinery, Cooling Tower, Crusher, Material Handling
IE3 Motors	56 to 355	0.12 to 355	2, 4, 6, 8		<ul style="list-style-type: none"> Ambient: 50° C Inverter Duty Winding Duty: S1 VPI: With Class H solvent less Resin Mounting: B3, B5, B35, V1 	<ul style="list-style-type: none"> Insulation: Class H Space Heater: 90 Frame onwards PTC Thermistor: 80 to 225 Frame Shaft Material: EN24* Enclosure: IP56 / 65 / 66 Roller Bearing: 160 Frame onwards 	<ul style="list-style-type: none"> Non standard shaft diameter/extension* Non Standard Paint Provision for Encoder Mounting Low Vibration as per IS or IEC 	Fans, HVAC, Pumps, Textiles, Hydraulic Press
Large LT Motors (DCCA)	355 to 450	250 to 1250	2, 4, 6, 8		<ul style="list-style-type: none"> Ambient: 45° C Inverter Grade Winding: For IE3 Motors Duty: S1 Mounting: B3, B5, B35, V1 	<ul style="list-style-type: none"> Non Standard Voltage: 220 to 690V Intermittent Duty S3, S4: In 4, 6, 8 Pole* Insulation: Class H PTC Thermistor: 80 to 315 L Space Heater: 90 Frame onwards Roller Bearing: 160 Frame onwards Shaft Material: EN24* Enclosure: IP56 / 65 / 66 	<ul style="list-style-type: none"> Insulated Bearing: 132 Frame onwards Non standard shaft diameter/extension* Motors for inverter duty application ; offered with <ul style="list-style-type: none"> Combined testing of motor and VFD or Motors fitted with PTC Thermistor Test facility available for combined Testing with VFD Non Standard Paint Low Vibration as per IS or IEC 	Pump, Fan, Compressor, Material Handling, Agitator, LPG Bottling Plant, Pharma Machinery, Chemical Plant Machinery, Machinery for Mines
IE4 Motors	112 to 225	1.5 to 45	4		<ul style="list-style-type: none"> Ambient: 50° C Duty: S1 Mounting: B3, B5, B35, V1 	<ul style="list-style-type: none"> Insulation: Class H Shaft Material: EN24* Enclosure: IP56 / 65 / 66 Roller Bearing: 160 Frame onwards 	<ul style="list-style-type: none"> Insulated Bearing: 132 Frame onwards Non standard shaft diameter/extension* Motors for inverter duty application with combined testing of motor and VFD for temperature class certification Test facility available for combined testing with VFD Non Standard Paint Low Vibration as per IS or IEC 	Pump, Fan, Compressor, Material Handling, Agitator, Pharma Machinery
Standard Flame Proof Ex'd' Motors	80 to 315	0.37 to 200	2, 4, 6, 8		<ul style="list-style-type: none"> Ambient: 45° C Inverter Grade Winding: For IE3 Motors Duty: S1 Mounting: B3, B5, B35, V1 	<ul style="list-style-type: none"> Duty: S2, S3 and S5 Non Standard Voltage: 380 to 460V Insulation: Class H Space Heater: 90 Frame onwards BTD: 250 Frame and above PTC Thermistor: 80 to 355 L Roller Bearing: 160 Frame onwards Shaft Material: EN24* Enclosure: IP56 / 65 / 66 	<ul style="list-style-type: none"> Motors for Inverter Duty Insulated Bearing: 132 Frame onwards Non standard shaft diameter/extension* Non Standard Paint Low Vibration as per IS or IEC 	Crane, Hoist, Lift, Material Handling, Car Stacker, Door Opening
IE2 Flame Proof Ex'd' Motors	80 to 315	0.37 to 200	2, 4, 6, 8		<ul style="list-style-type: none"> Ambient: 50° C Duty: S1 Mounting: B3, B5, B35, V1 (B14 upto 132 Frame) 	<ul style="list-style-type: none"> Duty: S2 and above Non Standard Voltage: upto 460V Motors for Inverter Duty Manual Release Arrangement: For 90 to 132 Frame 	<ul style="list-style-type: none"> Non standard shaft diameter/extension* Non Standard Paint 	Crane, Hoist, Material Handling, Textile, Pharma to name a few
IE3 Flame Proof Ex'd' Motors	80 to 315	0.37 to 180	2, 4, 6, 8		<ul style="list-style-type: none"> Ambient: 50° C Duty: S1 Mounting: B3, B5, B35 External Mounted DC Brake/Arrangement 	<ul style="list-style-type: none"> Duty: S2 and above Non Standard Voltage: upto 460V Motors for Inverter Duty Manual Release Arrangement 	<ul style="list-style-type: none"> Double Shaft Extension for Brake Arrangement Non Standard Paint 	Crane, Hoist, Material Handling, Textile, Pharma to name a few
IE2 Increased Safety Ex ec Motors	63 to 355	0.12 to 355	2, 4, 6, 8		<ul style="list-style-type: none"> Ambient: 45° C Duty: S3, S4, S5 Mounting: B3 	<ul style="list-style-type: none"> Non Standard Voltage: upto 500V Insulation: Class H 	<ul style="list-style-type: none"> Motors for Inverter Duty Non Standard Paint Low Vibration as per IS 	Ginning, Textile Machinery
IE3 Increased Safety Ex ec Motors	63 to 355	0.12 to 355	2, 4, 6, 8		<ul style="list-style-type: none"> Ambient: 45° C Start/Stop per Hour: upto 900 Duty: S5, 50% CDF Thermostat Mounting: B3, B5, B35 Forced Cooling Shaft Material: En24 	<ul style="list-style-type: none"> Insulation: Class H PTC Thermistor 	<ul style="list-style-type: none"> Insulated Bearing: 132 Frame onwards Non Standard Paint 	Cane Loading-Unloading Machine
Crane & Hoist Duty Motors	71 to 355	0.37 to 400	4, 6, 8					
Brake Motors (With Integral DC Brake)	71 to 132	0.25 to 9.3	2, 4, 6, 8					
Brake Motors (With External Mounted Brake)	71 to 200	0.37 to 22	2, 4, 6, 8					
Slip Ring Motors	100 to 160	1.1 to 10	4, 6					
Textile Motors	100 to 160	1.1 to 15	4, 6, 8					
Cane Unloader Motors	160 to 225	11 to 30	6					

CERTIFICATIONS



Super Premium Energy Efficient
SynchroVERT IE4 Motor:
 Winner of CII's Most Innovative
 Energy Saving Product 2016

New Product



Ultra Premium Energy Efficient
 IE5 Motor:
 Winner of CII's Most Innovative
 Energy Saving Product 2018

Upcoming Product



ISO 9001 : 2015



ISO 45001:2018



ISO 14001 : 2015



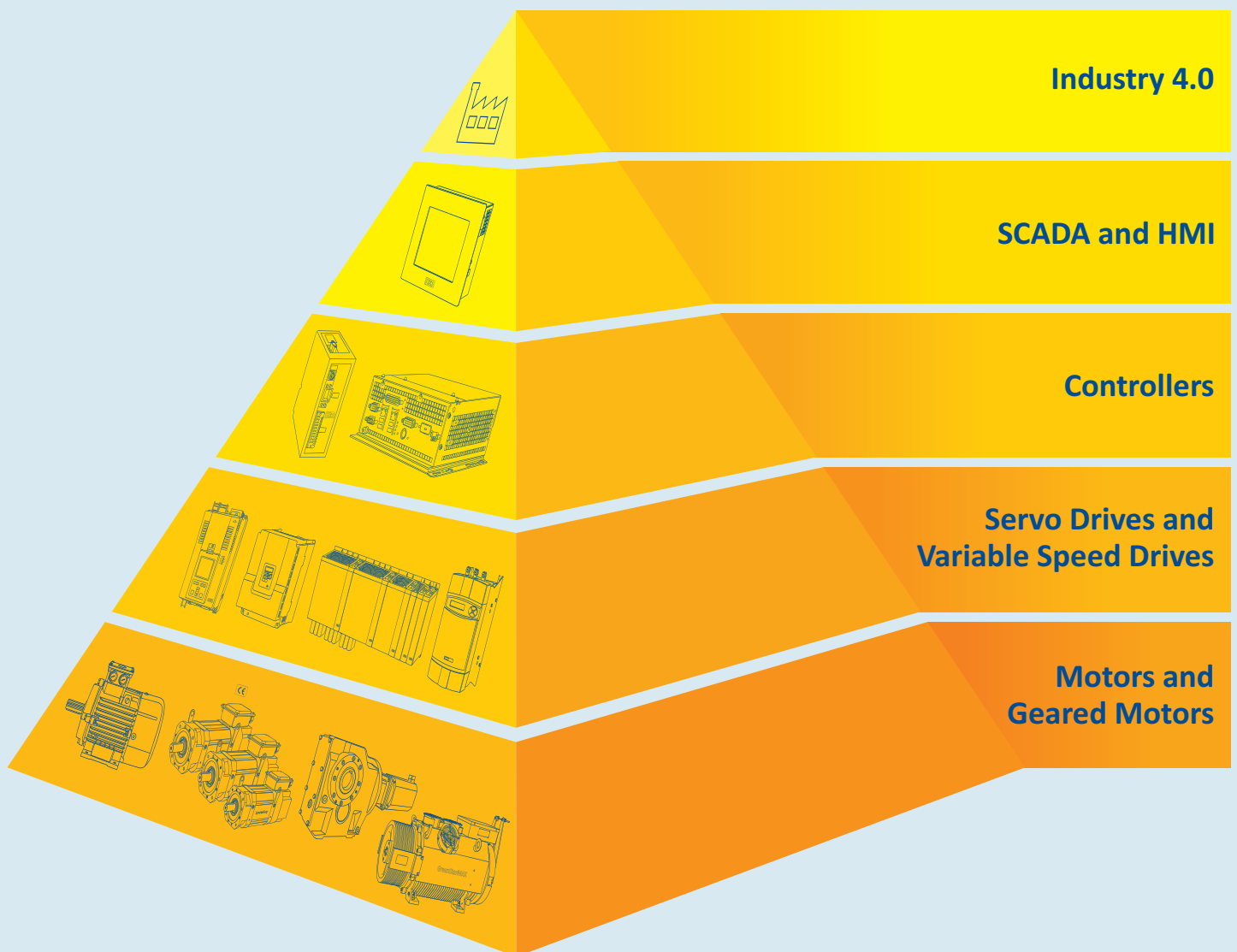

INDUSTRIAL AUTOMATION PYRAMID

**ENABLING PRODUCTIVITY,
PRECISION & ENERGY EFFICIENCY**



Bharat Bijlee's Industrial Systems product portfolio caters to a spectrum of applications and spans the machine automation pyramid.

ALL INDIA SERVICE NETWORK

-  Regional Offices
-  Works
-  Authorised Service Centre: Motors
-  Service Centre: Servo Motors



REGIONAL OFFICES

- Mumbai** +91 22 61457200
- Pune** +91 7410011271 / 72
- Ahmedabad** +91 79 66049200
- New Delhi** +91 11 25816931 / 32 / 33
- Indore** +91 731 2524474 / 2514486
- Ludhiana** +91 161 2775692 / 93
- Jaipur** +91 141 2377223
- Kolkata** +91 33 24432383 / 2467 / 40623076 / 77
- Bengaluru** +91 80 25592646 / 2137 / 2681
- Chennai** +91 44 2815 4793 / 94
- Secunderabad** +91 40 27801791 / 27814512
- Coimbatore** +91 422 4204314

For any enquiries please write to motorlvsales@bharatbijlee.com



+91 22 - 2763 7290 | serviceline@bharatbijlee.com



REGISTERED OFFICE
 Electric Mansion, 6th Floor,
 Appasaheb Marathe Marg,
 Prabhadevi, Mumbai 400 025
 T: +91 22 2430 6237 / 6375
 E: info@bharatbijlee.com
 CIN: L31300MH1946PLC005017

WORKS
 No. 2, MIDC Thane-Belapur Road, Airoli,
 Navi Mumbai 400 708
 T: +91 22 2763 7200 / +91 22 2760 0401
www.bharatbijlee.com

All product designations may be trademarks or product names of Bharat Bijlee Ltd, or of its partner or supplier companies, and whose use by third parties for their own purposes could violate the rights of the owners.

Product improvement is a continuous process and technical information herein is subject to change. Please contact our nearest sales office for the latest information.